

GRUA TORRE / TOWER CRANE

GRUE A TOUR / БАШЕННЫЙ КРАН /

KULE VINÇ / رافعة برجية

J1125**HD**
HEAVY DUTY**DC**

FEM 1001

UNE-EN-ISO 9001

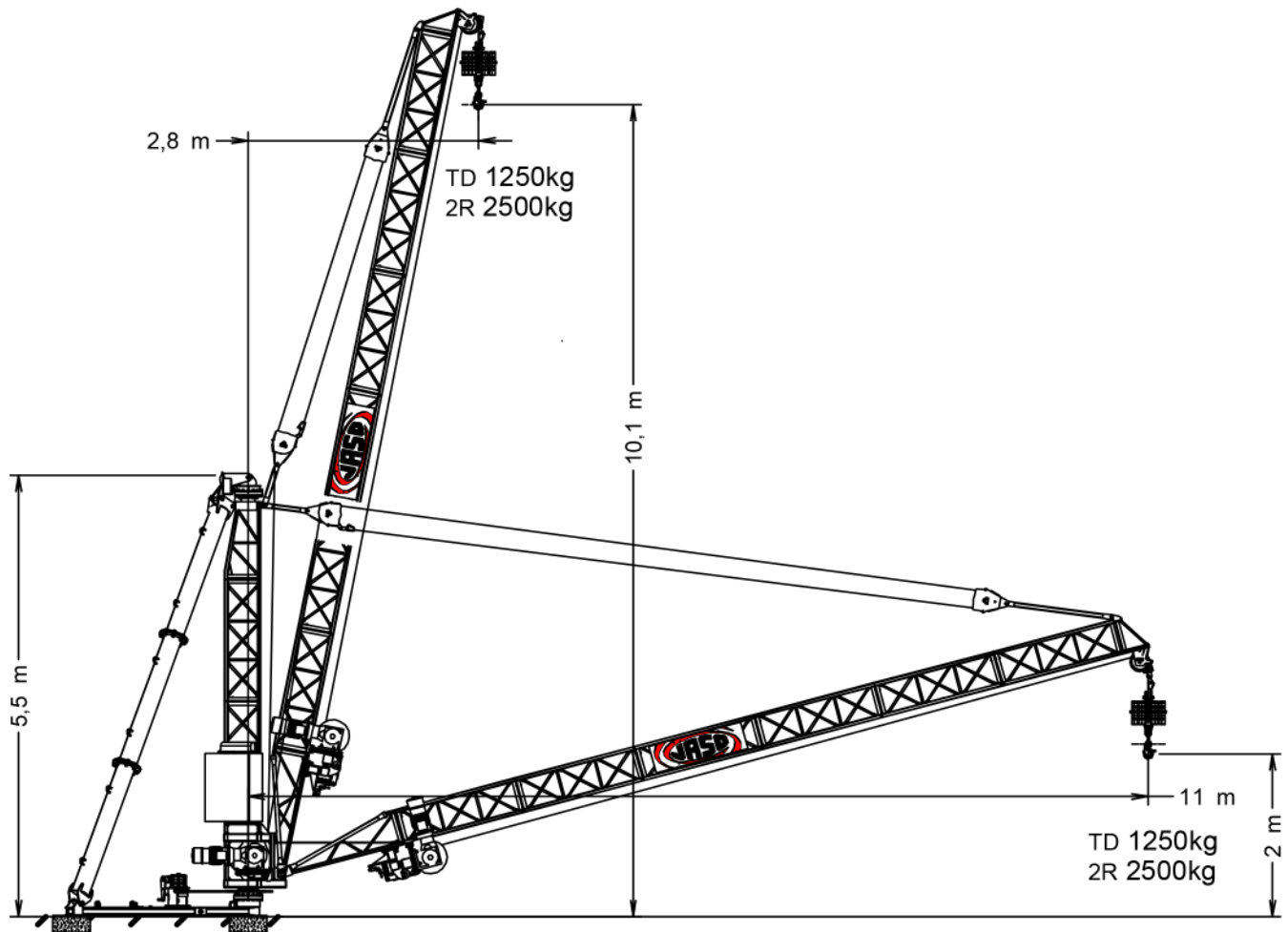
**CARGAS / LOADS / CHARGES / НАГРУЗКИ / YÜKLER / الأحمال****J1125.DC**

TD/2R (kg)

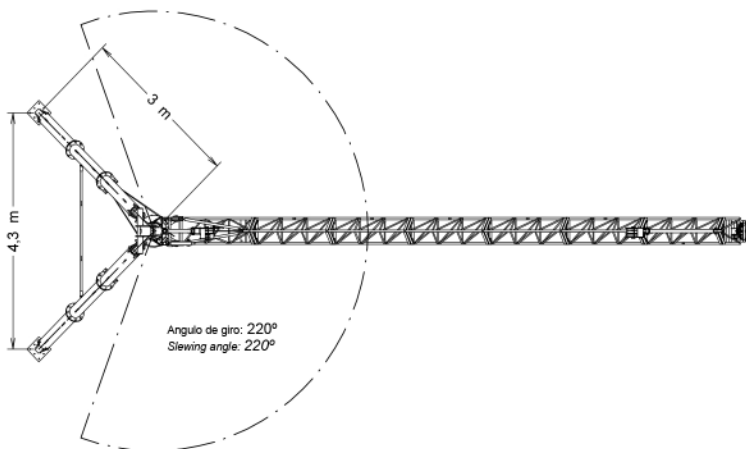
CARGAS / LOADS / CHARGES / НАГРУЗКИ / YÜKLER / الأحمال /
TD/2R – 1250/2500**TRANSPORTE / TRANSPORT / TRANSPORT**
TRANСПОРТИРОВКА / TAŞIMA / نقلTransporte grúa completa / Transport of whole crane /
Transport de la grue complete / Транспортировка
крана в сборе / Komple vinç taşıma / نقل الرافعة كاملةCaja marítima / Liftvan /
Cadre pour transport maritime
Контейнер для транспортировки морским транспортом
Ahşap konteyner
حاوية بحرية







2700x2250x2000mm

JASO EQUIPOS DE OBRAS Y CONSTRUCCIONES, S.L.**FEM 1005 – C25**





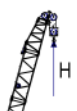





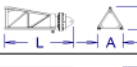
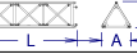
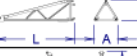

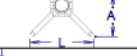

Reservado el derecho a modificaciones sin previo aviso. Declinamos toda responsabilidad derivada de la información proporcionada / Subject to modification, without previous warning. This information is supplied without liability / L'entreprise se réserve le droit de procéder à des modifications sans préavis. Nous déclinons toute responsabilité quant aux informations fournies / Мы оставляем за собой право на внесение изменений без предварительного уведомления. Мы снимаем с себя любую ответственность в отношении предоставленной информации / Önceden bildirilmeksizin değiştirilme hakkı saklıdır. Verilen

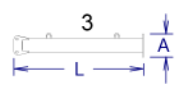
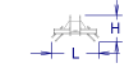
bilgiler için hiçbir sorumluluk kabul etmemekteyiz / حقوق التغيير محفوظة دون إشعار مسبق. دون أدنى مسؤولية عن المعلومات المقدمة.

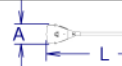

*opcional *optional *en option *опция *opsiyonel *اختياري					
		EC530VF 4 kW		EP515 4 kW	
	t m/min	0,7 0...30	1,25 0...18	1,5 min	
	t m/min	1,5 0...15	2,5 0...9		
		H ≤	TD 402m 2R 201m	 400V 50Hz P_{TOTAL}(EC530VF + EP515) = 8 kW	

LISTA DE EMBARQUE / PACKING LIST / LISTE DE COLISAGE / СПИСОК ПОСТАВКИ / ÇEKİ LİSTESİ / قائمة التحميل J1125.DC

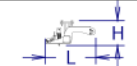
DENOMINACIÓN / DENOMINATION / DÉSIGNATION / НАЗВАНИЕ / AÇIKLAMA / اسم	L (m)	A (m)	H (m)	P / W (kg)		
Torre inferior + orientación / Lower tower + slewing / Tour inférieure+ orientation / Нижняя башня + поворотный механизм/ Alt kule + mekanizma/ البرج السفلي + آلية الدوران		1,005	0,49	0,76	150	
Punta de torre / Tower head / Porte-flèche / Верхняя секция башни / Kulenin kafa bölümü / قاعدة رأس البرج		1,312	0,49	0,44	108	
Tramo de pluma - Torre / Jib section - Tower / Tronçon de flèche - Tour / Секция стрелы - Башня / Bom bölümü - Kule / أجزاء الذراع - برج		1,565	0,49	0,44	38	
Tramo de pluma I / Jib section I / Tronçon de flèche I / Секция стрелы I / Bom bölümü I / I أجزاء الذراع		1,645	0,49	0,44	62	
Punta de pluma / Jib end / Pointe de flèche / Конец стрелы / Bom ucu / مقدمة الذراع		0,39	0,49	1,020	42	
Base grúa / Crane base / Base de la grue / Основание крана / Vinç tabanı / قاعدة الرافعة		1,300	0,875	-	72	
Larguero inferior / Lower crossbar / Traverse inférieure / Нижняя продольная балка / Alt giriş / عارضة سفلية		2,380	0,320	-	78	
Puntal / Pillar / Mât / Стойка / Gergi kolu / دعمة		1	1,922	0,350	-	93
		2	1,790	0,350	-	96
		3	1,905	0,350	-	98
Amarre puntales / Pillar fastening / Fixation des mâts / Крепление стоек / Demirleme gergi kolları / مثبت دعمة		0,906	-	0,498	81	
Plumín / Auxiliary jib / Fléchette / Дополнительная стрела / Vinç kolu / ريشة اضافية		3,340	0,673	-	41	
Polipasto / Hook assembly / Palan / Полуснаст / Kanca takımı / بكرة		0,387	0,841	-	210	
Pasteca / Reaving block		1	1,168	0,333	-	40
		2	1,720	0,307	-	42
Armario electric / Electrical cupboard / Armoire électrique / Электрический шкаф / Elektrik panosu / خزانة كهربائية		0,983	-	0,360	70	
Elevación pluma / Luffing / Relevage de flèche / Подъем стрелы / Yük kaldırma ve indirme / رافع الذراع		0,930	-	0,480	175	
Elevación carga / Hoisting / Levage de charge / Подъем груза / Yük kaldırma / رافع الحمولة		1,043	-	0,795	278	
Limitador sobrecarga / Overload limiter / Limiteur de surcharge / Ограничитель перегрузки / Aşırı yük sınırlayıcı / محدد الحمولة الزائدة		0,740	-	0,377	79	



JASO EQUIPOS DE OBRAS Y CONSTRUCCIONES, S.L.

Ctra./Rd. Madrid - Irún Km. 415
20.213 IDIAZABAL [Gipuzkoa]
ESPAÑA / SPAIN
P.O. Box, 23 - 20.200 BEASAIN

Tel. +34 943 - 18 70 00
Fax. +34 943 - 18 70 20
E-mail: jaso@jaso.com
http://www.jaso.com

Fecha / Date: 15-03-2013

Reservado el derecho a modificaciones sin previo aviso. Declinamos toda responsabilidad derivada de la información proporcionada / Subject to modification, without previous warning. This information is supplied without liability / L'entreprise se réserve le droit de procéder à des modifications sans préavis. Nous déclinons toute responsabilité quant aux informations fournies / Мы оставляем за собой право на внесение изменений без предварительного уведомления. Мы снимаем с себя любую ответственность в отношении

предоставленной информации / Önceden bildirilmeksizin değiştirilme hakkı saklıdır. Verilen bilgiler için hiçbir sorumluluk kabul etmemekteyiz / حقوق التغيير محفوظة

دون إشعار مسبق دون أدنى مسؤولية عن المعلومات المقدمة



HEAVY DUTY S.A.

Panamericana Norte Km 25
Lampa, Santiago
CHILE

Tel: (+56 2) 2 952 7800

E-mail: info@heavyduty.cl

www.heavyduty.cl

Representantes exclusivos en Chile de Jaso.