

$H_{DR} = H_{SR} - 0,53$

Altura máxima bajo gancho sin arriostrar (m).
 Maximum height under hook without fastening (m).
 Hauteur maximale sous crochet sans ancrage (m).
 Максимальная высота под крюком без крепления (m).
 Bağıntısız maksimum kanca altı yüksekliği (m).
 أقصى ارتفاع تحت الخطاف بدون ربط (m)

$H_{SR} =$

P14-1R	145.40.500	TM6-150	161.35.700
P14-2N	145.41.500	T3-150	161.32.000
P14-3R	145.42.700	T6-150	161.31.000
P14-4N	145.43.000	TD6-150	161.31.700
P14-11N	141.43.500	TM6-150	161.35.000
P14-12N	141.44.500	T12-150	161.31.500
P14-13N	141.45.500	AN 150	161.21.000
P14-14N	141.46.500	BNI 45-150	161.20.500
P14-8N	145.47.500	BNI 6-150H	161.20.300
		ABH 100	201.23.000

(H) TRASLACION / TRAVELLING /

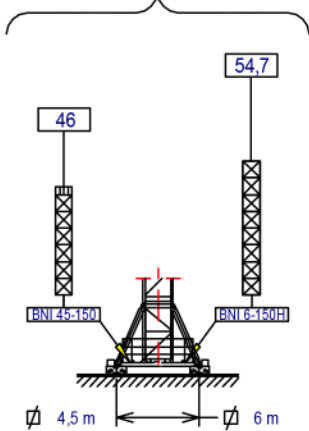

TRASLACION / ПЕРЕМЕЩЕНИЕ / RAY YÜRÜYÜŞLÜ / متحركة



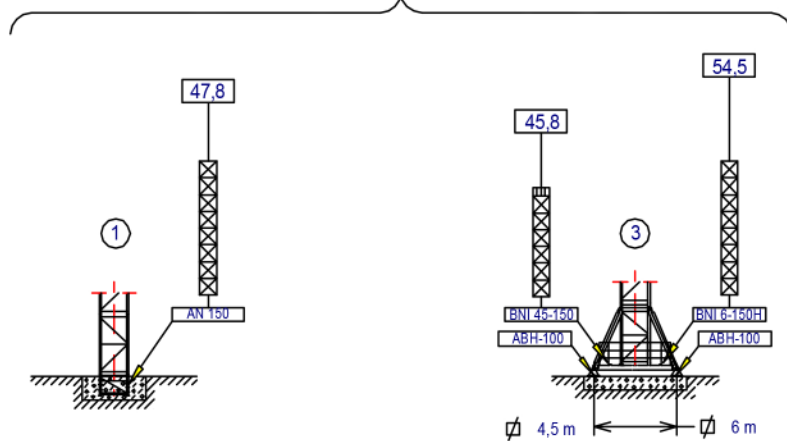

(H) ESTACIONARIA / STATIONARY /













STATIONAIRE / СТАЦИОНАРНОЕ СОСТОЯНИЕ / SABIT / ثابتة

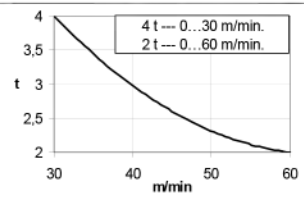
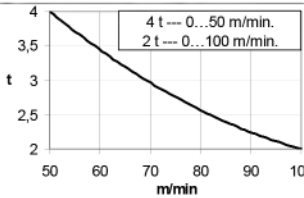

	SR (kg)	Cargas máximas / Maximum loads / Charges maximales / Максимальные нагрузки / Maksimum yük / أقصى حمولة SR-4.000 kg						4000 kg @ ... (m)	
	[m]	Alcance del gancho [m] / Hook reach [m] / Portée du crochet (m) / Радиус действия крюка (m) / Kancanın yüksekliği (m) / مدى الخطاف							
		60	55	50	45	40	35	30	
60 m		2000	2180	2445	2770	3175	3695	3980	32,7 m
55 m		—	2200	2465	2790	3195	3715	4000	32,76 m
50 m		—	—	2750	3105	3550	4000	4000	35,96 m
45 m		—	—	—	3250	3715	4000	4000	37,42 m
40 m		—	—	—	—	3800	4000	4000	38,20 m
35 m		—	—	—	—	—	4000	4000	35 m
30 m		—	—	—	—	—	—	4000	30 m

	SR / DR (kg)	Cargas máximas / Maximum loads / Charges maximales / Максимальные нагрузки / Maksimum yük / أقصى حمولة SR/DR - 4000/8000kg								4000 / 8000 kg @ ... (m)	
	[m]	Alcance del gancho [m] / Hook reach [m] / Portée du crochet (m) / Радиус действия крюка (m) / Kancanın yüksekliği (m) / مدى الخطاف									
		60	55	50	45	40	35	30	25	20	
60 m		1750	1940	2200	2510	2905	3410	4000/4090	4000/5030	4000/6450	30,6 / 16,4
55 m		—	1950	2210	2520	2915	3420	4000/4100	4000/5040	4000/6460	30,62 / 16,42
50 m		—	—	2500	2850	3280	3840	4000/4580	4000/5625	4000/7190	33,78 / 18,12
45 m		—	—	—	3000	3450	4000/4035	4000/4810	4000/5900	4000/7530	35,27 / 18,92
40 m		—	—	—	—	3550	4000/4145	4000/4940	4000/6055	4000/7725	36,11 / 19,36
35 m		—	—	—	—	—	4000/4250	4000/5060	4000/6200	4000/7905	35 / 19,78
30 m		—	—	—	—	—	—	4000/5200	4000/6365	4000/8000	30 / 20,26

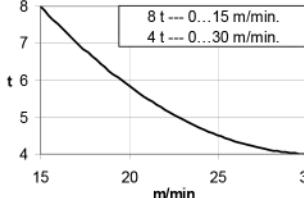
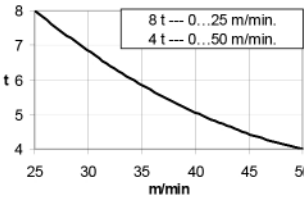
CARACTERISTICAS DE MECANISMOS / MECHANISMS FEATURES / CARACTÉRISTIQUES DES MÉCANISMES / ХАРАКТЕРИСТИКИ МЕХАНИЗМОВ / MEKANİZMALARIN ÖZELLİKLERİ / الخصائص الآلية J145.A

*opcional *optional *en option *опция *opsiyonel *اختياري							
	EC3360VF 24,3 kW	*EC4880 35,3 kW	*EC60100VF 44,1 kW	TG2020VF 2x7,3 kW	OG1508VF 2x5,5 kW	TC465VF 3 kW	TH1506 11 kW
		2 4 4 80 40 10		0,20 m/min	0,2 0,2 0,4 0,4 0,8 r/min sl/min	0,15 15,32 32,65 m/min	1 m/min
		4 8 8 40 20 5		400V 50Hz	$P_{TOTAL}(EC3360VF + OG1508VF + TC465VF) = 38,3 \text{ kW}$ $P_{TOTAL}(EC4880 + OG1508VF + TC465VF) = 49,3 \text{ kW}$ $P_{TOTAL}(EC60100VF + OG1508VF + TC465VF) = 58,1 \text{ kW}$		
	$H \leq$ SR 322 m DR 161 m	$H \leq$ SR 534 m DR 267 m		480V 60Hz	EC4880	kW +20% m/min +20%	



LISTA DE EMBARQUE / PACKING LIST / LISTE DE COLISAGE / СПИСОК ПОСТАВКИ / ÇEKİ LİSTESİ / قائمة التحميل J145.A

DENOMINACIÓN / DENOMINATION / DÉSIGNATION / НАЗВАНИЕ / AÇIKLAMA / اسم		L [m]	A [m]	H [m]	P / W [kg]		
Torre inferior / Lower tower / Tour inférieure / Нижняя башня / Alt kule / البرج السفلي	T16-90			6,175	2,190	2,190	3.535
Torre / Tower / Tour Башня / Kule / برج	T6-150 TD6-150 TT6-150 T3-150 T12-150			6,175 6,175 6,175 3,265 12,000	1,870 1,870 1,870 1,870 1,870	1,870 1,870 1,870 1,870 1,870	2.760 2.930 2.760 1.550 5.180
Torre asiento pista + base punta de torre + orientación Slewing table + tower head base + slewing mechanism Tour pivot + base du porte-flèche + mécanisme d'orientation Сиденье площадки + основание верхней секции башни + поворотный механизм Göbek + kule kafa bölümü tabanı + mekanizma برج وحدة الدوارن + قاعدة رأس البرج + الية الدوران				4.530	2.100	2.035	5227
Punta de torre / Tower head / Porte-flèche верхняя секция башни / kulenin kafa bölümü / رأس البرج				7,661	1,225	1,525	1410
Conjunto asiento pista, punta de torre, orientación Slewing table assembl + tower head + slewing Groupe pivot + porte-flèche + mécanisme d'orientation Сиденье площадки + верхняя секция башни + поворотный механизм Göbek + kulenin kafa bölümü + mekanizma مجموعة وحدة الدوارن + رأس البرج + الية الدوران				11	2.100	2.035	7600
Tramo de pluma Jib section Tronçon de flèche Секция стрелы Bot bölümü أجزاء الذراع	P14-1R (I) P14-2N (II) P14-3R (III) P14-4N (IV) P14-11N (V) P14-12N (VI) P14-13N (VII) P14-14N (VIII) P14-8N (IX)			8,665 10,160 10,160 5,270 10,145 5,255 5,255 5,250 2,095	1,366 1,226 1,226 1,226 1,226 1,226 1,226 1,226 1,366	1,698 1,630 1,630 1,630 1,608 1,535 1,535 1,530 1,740	1030 1150 1130 495 780 355 305 270 195
Polipasto / Hook assembly / Paan / Попуспаст / Kanca takımı / بكرة	SR DR			0,99 1,04	0,303 0,337	1,067 1,718	192 347
Tirante sostén pluma / Jib support tie / Tirant de fleche / Растяжка поддержки стрелы / Kol destek bağları / مشد دعامة الذراع	Largo / Long / Corto / Short			5,30 4,90	0,70 0,445	1,750 1,750	1030 443
Carro / Trolley / Chariot / Грузовая тележка / Şaryo / عربة	SR DR			1,584 1,320	2,400 2,366	1,541 1,541	260 350
Contrapluma con plataformas / Counterjib with platforms Contre-flèche avec plateformes / Противовесная консоль с платформами / Platformlu kuyruk / الذراع المقابل مع المنصة				11,810	2,984	0,5	2500
Prolongación contrapluma con plataforma / Counterjib extension with platform Prolongement contre-flèche avec plateforme / Удлинение противовесной консоли с платформой / Kuyruk platformla uzatılması / امتداد الذراع المعاكس مع الممرات				2,750	2,3	0,5	815
Soporte y elevación / Support and hoisting / Support et levage / Опора и подъем / Destek ve vinç kulesi / دعم ورفع	EC3360VF EC4880 EC60100VF			2,655 2,655 2,655	2,315 2,315 2,315	1,750 1,750 1,750	2160 2480 2625
Plataforma y cabina / Platform and cabin / Plateforme et cabine Платформа и кабина / Platform ve kabin / منصة وكابينة				3,760	2,050	2,400	1280
Lastre / Ballast / Lest / Балласт / Alt ağırlık taşları / ثقل				3,800	0,580	1,500	6000
Estructura torre de montaje / Jacking cage structure / Structure de tour de montage / Структура монтажной башни / Kaldırma kafesi yapısı / هيكل برج التركيب	TM 6-150			10,320	2,420	2,310	3500

LASTRES INFERIORES / LOWER BALLASTS / LESTS INFÉRIEURS / НИЖНИЙ БАЛЛАСТ / BALAST / ثقل J145.A

BNI 45-150	H (m)	19,6	31,2	40	46
	P (t)	48	60	72	96
BNI 6-150H	H (m)	42,8	—	48,7	54,7
	LI=12t P (t)	LI+36	LI+48	LI+60	LI+84

H: Altura bajo gancho / Height under hook / Hauteur maximale sous crochet Высота под крюком / Kanca altı yüksekliği / الارتفاع أسفل الحطاف
P: Peso / Weight / Poids / Вес / Ağırlık / وزن
Para alturas intermedias tomar el lastre correspondiente a la altura superior / For intermediate heights take the ballast corresponding to the higher height / Pour les hauteurs intermédiaires, opter pour le lest correspondant à la hauteur immédiatement supérieure / Для промежуточных высот возьмите балласт, соответствующий большей высоте / Orta yükseklikler için daha üst bir yüksekliğe karşılık gelen ağırlığı alınız / للارتفاعات البينية يرجى استخدام الثقل العائد للارتفاع الأعلى / حقنقاعات البينية يرجى استخدام الثقل العائد للارتفاع الأعلى



JASO EQUIPOS DE OBRAS Y CONSTRUCCIONES, S.L.

FEM 1005 – C25

Reservado el derecho a modificaciones sin previo aviso. Declinamos toda responsabilidad derivada de la información proporcionada / Subject to modification, without previous warning. This information is supplied without liability / L'entreprise se réserve le droit de procéder à des modifications sans préavis. Nous déclinons toute responsabilité quant aux informations fournies / Мы оставляем за собой право на внесение изменений без предварительного уведомления. Мы снимаем с себя любую ответственность в отношении предоставленной информации / Sınceden bildirimeksizin değıştirilme hakkı saklıdır. Verilen bilgiler için hiçbir sorumluluk kabul etmemekteyiz / حقوق التعديل محفوظة دون إشعار مسبق. دون أدنى مسؤولية عن المعلومات المقدمة

Fecha / Date 15-03-2013

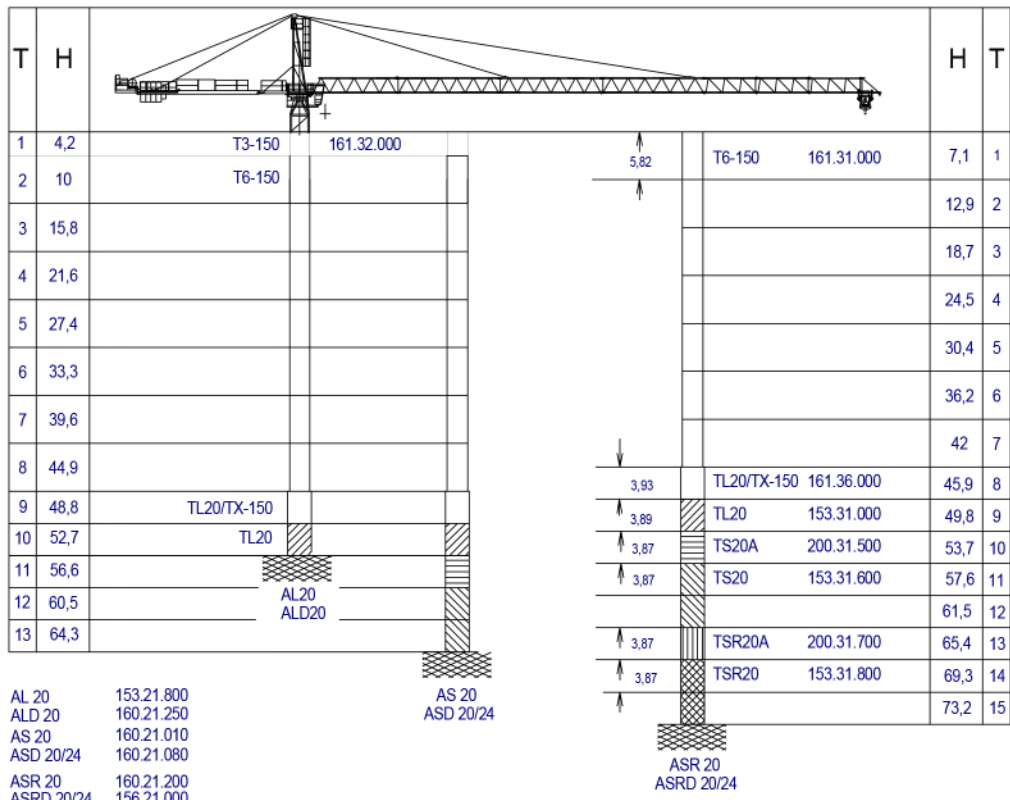

AL 20 153.21.800
 ALD 20 160.21.250
 AS 20 160.21.010
 ASD 20/24 160.21.080
 ASR 20 160.21.200
 ASRD 20/24 156.21.000

T: Torre / Tower / Tour / Башня / Kuleler / أبراج
 H: Altura / Height / Hauteur / Высота / Yükseklik / ارتفاع

Transporte / Transport / Transport / Транспортировка / Taşıma / نقل

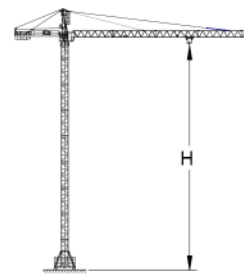

H=47,8; AN150

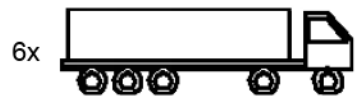

6x

7x HIGH CUBE 40'

Otras configuraciones de torre / Other tower configuration / Autres configurations / Прочие конфигурации / Diğer konfigürasyonlar / مكونات أخرى

TREPADO / CLIMBING / TÉLESCOPAGE / ЛЕСТНИЦА / TIRMANMA / التسلق

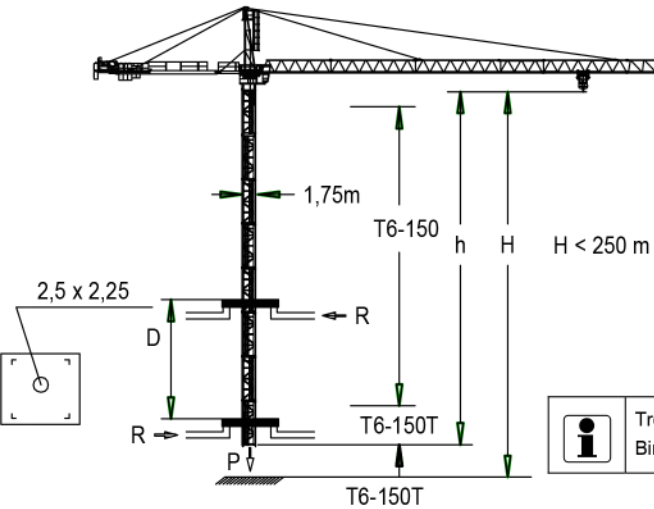

$h_{max} = T6-150T + 7 \times T6-150$

h (m)	44,9
D (m)	16,2 - 20
P (KN)	662 582
Rmax (KN)	104 260

T6-150T = 161.32.500

Trepado interno / Internal climbing / Télescopage interieur / Внутренняя лестница / Bina içi tırmanma / التسلق الداخلي

- Wiento fuera de servicio / Out of service wind / Vitesse du vent hors service / Ветровая нагрузка в покое / Rüzgar devre dışı / الريح خارج الخدمة
- Consultar / Consult / Nous consulter / Консультируйтесь / Danışınız / الرجوع الي
- En servicio / In service / En service / В работе / Devrede / في الخدمة
- Fuera de servicio / Out of service / Hors service / В покое / Devre dışı / خارج الخدمة



JASO EQUIPOS DE OBRAS Y CONSTRUCCIONES, S.L.
 Ctra./Rd Madrid - Irún Km. 415
 20 213 IDIAZABAL (Gipuzkoa)
 ESPAÑA / SPAIN
 P.O. Box, 23 - 20.200 BEASAIN
 Tel: +34 943 - 18 70 00
 Fax: +34 943 - 18 70 20
 E-mail: jaso@jaso.com
 http://www.jaso.com



HEAVY DUTY S.A.
 Panamericana Norte Km 25
 Lampa, Santiago
 CHILE

Tel: (+56 2) 2 952 7800
 E-mail: info@heavyduty.cl

www.heavyduty.cl

Representantes exclusivos en Chile de Jaso.

Reservado el derecho a modificaciones sin previo aviso. Declinamos toda responsabilidad derivada de la información proporcionada / Subject to modification, without previous warning. This information is supplied without liability. L'entreprise se réserve le droit de procéder à des modifications sans préavis. Nous declinons toute responsabilité quant aux informations fournies. Мы оставляем за собой право на внесение изменений без предварительного уведомления. Мы снимаем с себя любую ответственность в отношении предоставленной информации / Önceden bildirilmeksizin değiştirilme hakkı saklıdır. Verilen bilgiler için hiçbir sorumluluk kabul etmemekteyiz / حقوق التعديل محفوظة دون
 السعة مسبقا ، انظر مسبقا لثة عن المعلّمات المقدمة